

## Софтвери у грађевинарству

### ArchiCAD

Nacrtati sledece resetke I transformacija sa njima

Prva resetka 200mm kruzni profil debljina profila 20mm, profil kopirati 12 puta sa razmakom 200cm

Druga resetka pravougaoni profil 100 x 200mm debljina profila 15mm, preseći je komadom marquee

Treća resetka I profil visina 200 sirina 100 debljina 10mm, profil kopirati 9 puta u krug

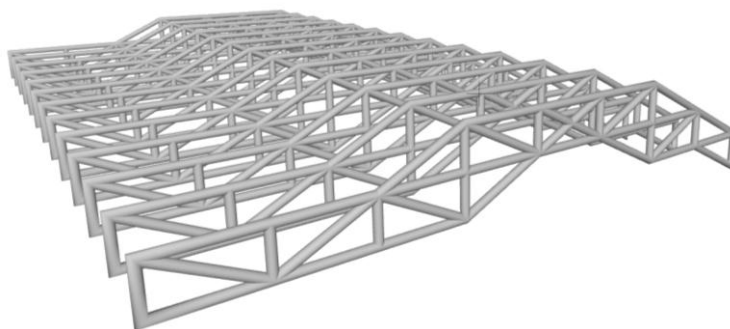
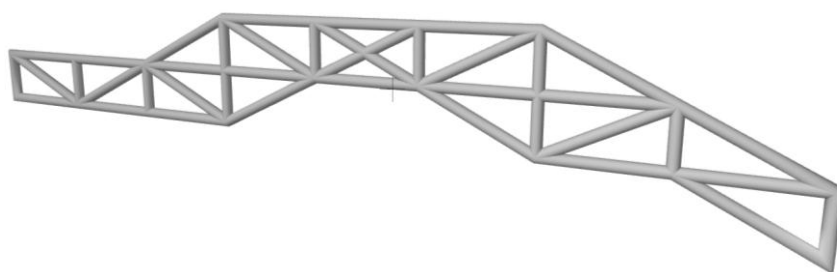
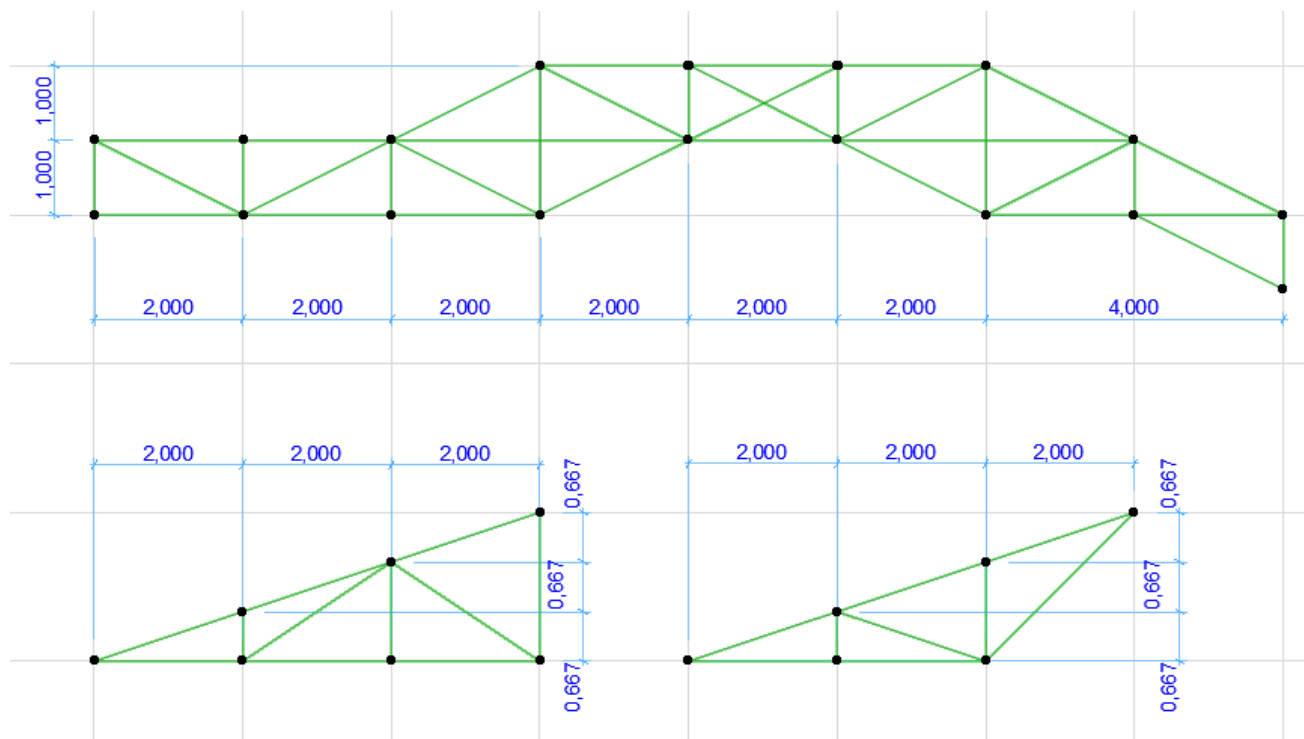

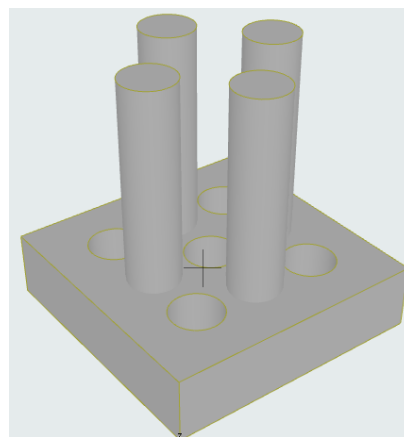
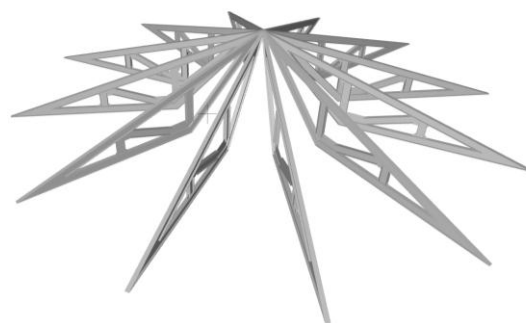
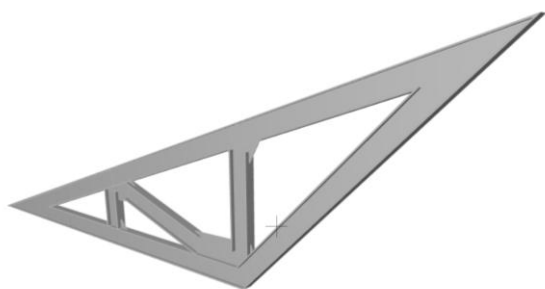
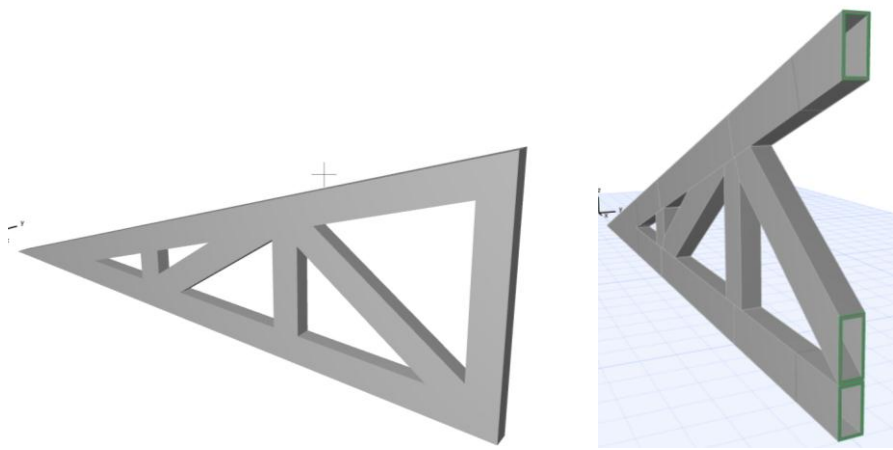

Nacrtati Morph sa slike

